

HM-TD2037T-4/X Thermographic Network Box Camera



The Thermographic Network Box Camera with small size, low power consumption and simple integration realizes real-time high-accuracy object temperature measurement.

▪ Key Feature

- 384 × 288 resolution, high sensitivity sensor
- Object temperature range: - 20 °C to 150 °C (- 4 °F to 302 °F), 0 °C to 550 °C (32 °F to 1022 °F); Max (± 2 °C, $\pm 2\%$)
- Temperature measurement at user-defined points, lines, and areas
- A highlighted cross at the max. temperature in the thermal image
- Thermal image frame rate: 50 fps
- Color alarm (isotherm) available for Above, Between, and Below object temperatures

▪ Specification

Thermal Module	
Image Sensor	Vanadium Oxide Uncooled Focal Plane Arrays
Resolution	384 × 288
Pixel Pitch	17 μm
Spectral Range	8 μm to 14 μm
NETD	< 35 mK (25 °C, F# = 1.0)
Focal Length	4.5 mm
IFOV	3.78 mrad
Field of View	90° × 65.2° (H x V)
Min. Focusing Distance	0.3 m
Aperture	F 1.0
Measurement and Analysis	
Object Temperature Range	- 20 °C to 150 °C (- 4 °F to 302 °F), 0 °C to 550 °C (32 °F to 1022 °F)
Temperature Accuracy	Max (± 2 °C, ± 2%)
Measurement Presets	Hot spot, cold spot in real time
Point	10 User Presets
Line	1 User Presets
Area	7 User Presets
Color Alarm (Isotherm)	Above/Between/Below
Thermographic Integration	
Temperature Metadata	Continuous output data of preset thermographic rules and measured temperature
Thermographic Data Encoding	4 fps, 32-bit 384 × 288 per frame
Thermographic Data Upload	Real-time full-screen thermographic data matrix (16-bit or 32-bit 384 × 288) via RTSP, ISAPI, and SDK
Raw Data Upload	Real-time full-screen YUV data via RTSP and SDK
Video and Image	
Main Stream	50 fps (384 × 288)
Video Compression	H.264/MJPEG
Color Palettes	15 options: White Hot, Black Hot, Fusion 1, Rainbow, Fusion 2, Ironbow 1, Ironbow 2, Speia, Color 1, Color 2, Ice Fire, Rain, Red Hot, Green Hot, Dark Blue
Digital Zoom	2 ×, 4 ×
Network	
Protocols	IPv4/IPv6, HTTP, HTTPS, 802.1x, QoS, FTP, SMTP, UPnP, SNMP, DNS, DDNS, NTP, RTSP, RTCP, RTP, TCP, UDP, IGMP, ICMP, DHCP, PPPoE
Simultaneous Live View	Up to 6 channels
User/Host level	Up to 32 users, 3 levels: Administrator, Operator, User
Security	User authentication (ID and PW), MAC address binding, HTTPS encryption, IEEE 802.1x(EAP-MD5, EAP-TLS), access control, IP address filtering
Client	iVMS-4800
Interface	
Alarm Input	1, alarm input (0-3.3 VDC)
Alarm Output	1, alarm output; NC, level quantity

Analog Output	1, CVBS output
Communication Interface	1, RJ45 10 M/100 M self-adaptive Ethernet interface 1, RS-485 interface (ModBus available)
General	
Menu Language	English
Power Supply	10-30 VDC, Max. 2.3 W
Working Temperature/Humidity	- 20 °C to 50 °C (- 4 °F to 122 °F) 90% or less
Protection Level	IP40
Mount	M3
Weight	Approx. 140 g (0.31 lb)
Dimensions	67 mm × 45 mm × 45 mm (2.64" x 1.77" x 1.77")

▪ Available Model

HM-TD2037T-4/X

Dimension

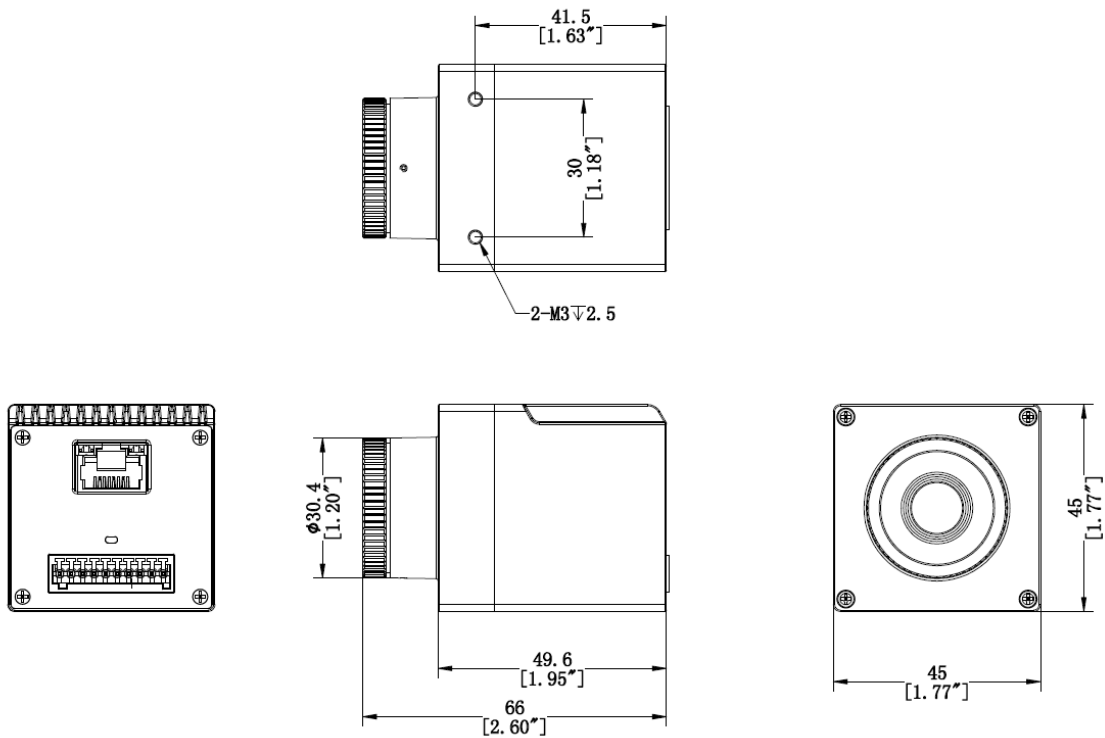

Unit:mm [Inch]

COMPLIANCE NOTICE: The thermal series products might be subject to export controls in various countries or regions, including without limitation, the United States, European Union, United Kingdom and/or other member countries of the Wassenaar Arrangement. Please consult your professional legal or compliance expert or local government authorities for any necessary export license requirements if you intend to transfer, export, re-export the thermal series products between different countries.

